

INSTRUCTION MANUAL

EC/TDS Meter



■ Mi 306

Automatic & Logging EC/TDS Meter

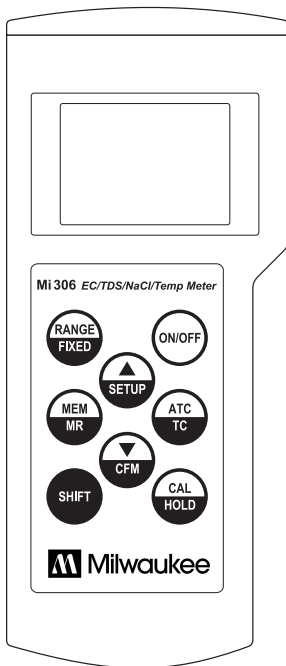

www.milwaukeeinst.com

Instruction Manual Mi 306 EC/TDS Meter

FUNCTIONAL DESCRIPTION	2
GENERAL DESCRIPTION	4
PROBE MAINTENANCE	5
SPECIFICATION	5
SETUP	7
TAKING MEASUREMENTS	9
AUTORANGING	10
AUTO ENDPOINT MODE	10
TEMPERATURE COMPENSATION	11
EC/TDS CALIBRATION	12
NACL CALIBRATION	13
LOGGING FUNCTION	14
DATA TRANSFER TO PC	17
BATTERY REPLACEMENT	18
CONDUCTIVITY VS TEMPERATURE CHART	18
ACCESSORIES	19

FUNCTIONAL DESCRIPTION

DISPLAY

- A. PRIMARY DISPLAY
- B. AUTO ENDPOINT MODE INDICATOR
- C. LOW BATTERY INDICATOR
- D. CALIBRATION MODE INDICATOR
- E. REQUIRE USER CONFIRMATION
- F. CALIBRATION TAGS
- G. MEASURING UNIT FOR PRIMARY DISPLAY
- H. PRIMARY DISPLAY MODE
- I. MEASURING UNIT FOR SECONDARY DISPLAY
- J. SECONDARY DISPLAY

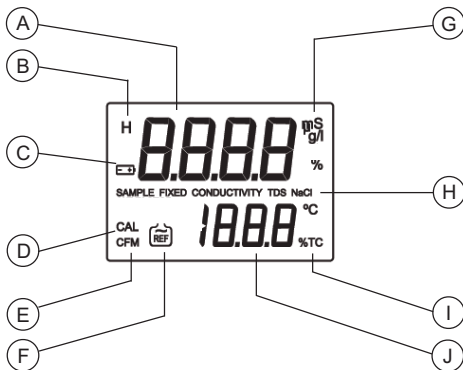

FUNCTIONAL DESCRIPTION

1. Liquid Crystal Display (LCD)
2. ON/OFF key, to turn the meter on and off
3. RANGE/FIXED key, to select measurement range or (with SHIFT) to fix the current range.
4. ▲/SETUP key, to move up or (with SHIFT) to enter setup mode.
5. ATC/TC key, to select temperature compensation mode or (with SHIFT) to view the temperature coefficient value.
6. MEM/MR key, to store or (with SHIFT) recall measurements.
7. ▼/CFM key, to move down or (with SHIFT) to confirm displayed choice.
8. SHIFT key, to enable inverse functions.
9. CAL/HOLD key, to enter calibration mode or (with SHIFT) to enter Auto Endpoint mode.
10. DIN connector for probe
11. RS232 plug

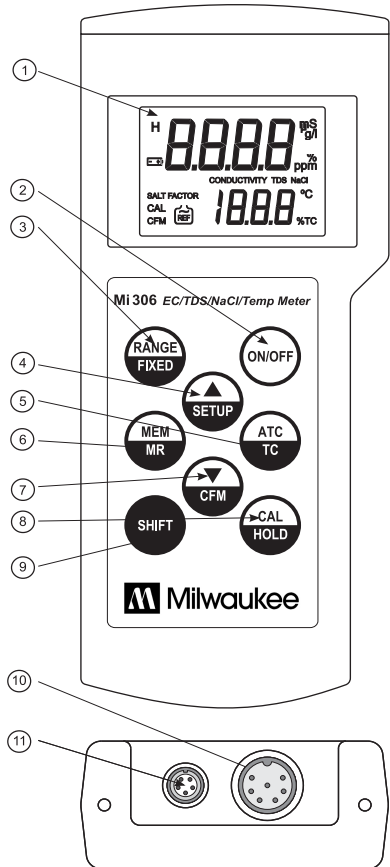

GENERAL DESCRIPTION

Thank you for choosing Milwaukee Instruments. This instruction manual will provide you the necessary information for correct use of the meter.

Mi306 is a waterproof portable logging microprocessor-based Conductivity/TDS/NaCl/temperature meter.

The autoranging feature of the EC and TDS ranges automatically sets the meter to the scale with the highest possible resolution.

The Auto Endpoint (HOLD) feature automatically freezes the display when a stable reading is reached.

The measurements are automatically (ATC) or manually (MTC) compensated for temperature. The temperature coefficient value is user selectable. It is possible to disable the temperature compensation and measure the actual conductivity (NOTC). The Battery Error Preventing System (BEPS) switches the meter off when the batteries are too weak to support proper function.

The meter can store measurements in memory by logging function for retrieval at a later time upon user request.

Mi306 also allows data transfer to computer through the RS232 port.

This EC/TDS/NaCl/Temp Meter is supplied with:

- MA914D/1 EC/TDS/NaCl Temp Electrode
- MA9066 12880 $\mu\text{S}/\text{cm}$ calibration solution, 230 mL
- MA9350 RS232 connection cable with 2 meters cable
- 12 VDC Adapter
- Instruction manual

This instrument is in compliance with the CE Directives.

PROBE MAINTENANCE

Rinse the probe with clean water after measurements. If a more thorough cleaning is required, remove the probe sleeve and clean the probe with a cloth or a nonabrasive detergent.

Make sure to reinsert the sleeve onto the probe properly and in the right direction.

After cleaning the probe, recalibrate the instrument.

SPECIFICATIONS

Range	EC (Autoranging)	0.00 to 29.99 $\mu\text{S}/\text{cm}$
		30.0 to 299.9 $\mu\text{S}/\text{cm}$
		300 to 2999 $\mu\text{S}/\text{cm}$
		3.00 to 29.99 mS/cm
		30.0 to 200.0 mS/cm
		Up to 500.0 mS/cm actual ⁽¹⁾ Conductivity
(Autoranging)	TDS	0.00 to 14.99 mg/L
		15.0 to 149.9 mg/L
		150 to 1499 mg/L
		1.50 to 14.99 g/L
		15.0 to 100.0 g/L
		Up to 400.0 g/L actual ⁽¹⁾ TDS (with 0.80 factor)
	NaCl	0.0 to 400.0 %
	Temp.	0.0 to 60.0 °C
Resolution	EC	0.01 $\mu\text{S}/\text{cm}$ (from 0.00 to 29.99 $\mu\text{S}/\text{cm}$)
		0.1 $\mu\text{S}/\text{cm}$ (from 30.0 to 299.9 $\mu\text{S}/\text{cm}$)
		1 $\mu\text{S}/\text{cm}$ (from 300 to 2999 $\mu\text{S}/\text{cm}$)
		0.01 mS/cm (from 3.00 to 29.99 mS/cm)
		0.1 mS/cm (over 30.0 mS/cm)
TDS		0.01 mg/L (from 0.00 to 14.99 mg/L)
		0.1 mg/L (from 15.0 to 149.9 mg/L)
		1 mg/L (from 150 to 1499 mg/L)
		0.01 g/L (from 1.50 to 14.99 g/L)
		0.1 g/L (over 15.0 g/L)
	NaCl	0.1 %
	Temp.	0.1 °C

SPECIFICATIONS

Accuracy	EC	±1% of reading ($\pm 0.05 \mu\text{S}/\text{cm}$ or 1 digit whichever greater)
	TDS	±1% of reading ($\pm 0.053 \text{ ppm}$ or 1 digit whichever greater)
	NaCl	±1% of reading
	Temp.	±0.4°C
Typical EMC	EC	±1% of reading
Deviation	TDS	±1% of reading
	NaCl	±1% of reading
	Temp.	±0.1 °C
Logging	250 records, LOG on demand or auto-logging	
Communication	with PC - RS232	
EC Calibration	1 point with 7 memorized buffers: 0, 84, 1413, 5000, 12880, 80000, 111800 $\mu\text{S}/\text{cm}$	
NaCl Calibration	1 point with HI 7037 buffer (optional)	
Temperature	2 points at 0 and 50°C	
Calibration	(plus $\pm 1^\circ\text{C}$ adjustment)	
Temperature	Automatic or Manual from 0 to 60°C	
Compensation	(can be disabled to measure actual conductivity)	
Temperature	0.00 to 6.00 %/°C (for EC and TDS only)	
Coefficient	Default value is 1.90%/°C	
Reference Temp.	20 or 25 °C	
TDS Factor	0.40 to 0.80 (default value is 0.50)	
Probe	MA 814D/1 EC probe with built-in temperature sensor & 1.1 m cable (included)	
Auto Off	After 5 minutes (can be disabled)	
Power supply	9V Battery (included) - approx. 100 hours of use	
Casing	IP 67	
Environment	0 to 50°C ; 100% RH	
Dimensions	200 x 85 x 50 mm (7.9 x 3.3 x 2.0")	
Weight	280 g (10 oz)	

SETUP



Setup is used to view or change the instrument parameters.

To enter setup press SHIFT+SETUP when the meter is in measurement mode.

"Set" is displayed on the upper LCD. The lower LCD displays the blinking code of the current setup item.

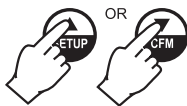
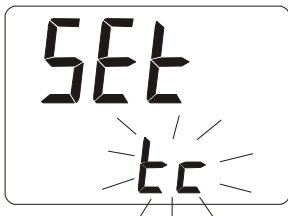

Select the desired setup item using the ▲ or ▼ key.



Press SHIFT+CFM to confirm.

Note: If SHIFT+SETUP are pressed before item confirmation, the meter will escape and return to measurement mode.

Once the desired setup item has been selected, its current value blinks (if it is a changeable parameter).

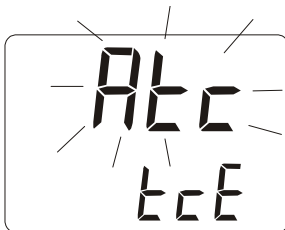

Instruction Manual Mi 306 EC/TDS Meter



To change the value use the ▲ or ▼ key.
Press SHIFT+CFM to confirm.

Note: Press SHIFT+SETUP before confirmation to escape without changing the previously set value.

The following table lists the setup items, their valid range of values and the factory settings (default):

Item	Description	Default	Valid value
tc	Temp. compensation coeff.	0.00 to 6.00 %/°C	1.90
tcE	Temp. compensation mode	Atc, Mtc, notc	Atc
rEF	Reference Temperature	20 or 25°C	25°C
tdS	TDS factor	0.40 to 0.80	0.50
CEL	Cell constant (K)	0.500 to 1.700	1.000
Aof	Auto-Off enable	On, OFF	On
YEA	Year	1999 to 2098	1999
dAT	Date	dd:mm	01:01
hou	Hour	hh:mm	00:00
uEr	Firmware release		
Chr	Battery level test		

Notes:

- 1 Once enabled, the Auto Off time is fixed at 5 minutes.
- 2 When the battery level test is selected (Chr), LCD will display the remaining percentage of battery charge. 100% means fully charged battery and 0% corresponds to the minimum battery level that allows the meter to operate.

The battery charge level calculation is based on a typical alkaline battery discharge curve.

If the meter is connected to an external power adapter and "Chr" is selected, the LCD will display "LINE".

- At startup, the main LCD shows briefly the reference temperature, while the secondary LCD shows "rEF".

TAKING MEASUREMENTS



Press the ON/OFF key to turn the meter on.

At startup the display will show the reference temperature value with "rEF" indication for a few seconds.



Immerse the probe into the solution to be tested. The sleeve holes must be completely submerged. Tap the probe repeatedly to remove any air bubbles that may be trapped inside the sleeve.



If needed, press the RANGE key repeatedly until the desired range (EC, TDS, NaCl) is selected on the LCD.

Allow for the reading to stabilize. The upper LCD displays the measure in the selected range while the temperature is displayed on the lower LCD.

Notes:

- If the meter displays "----", the reading is out of range.
- If the reading is not stable, the stability indicator "~" blinks.

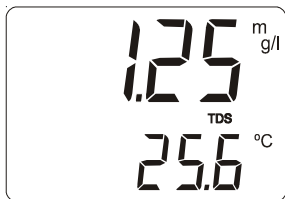

- 3 Make sure the meter is calibrated before taking measurements.
- 4 If measurements are taken successively in different samples, to have accurate readings it is recommended to rinse the probe thoroughly with deionized water before immersion in the samples.
- 5 To maximize battery life, the meter is automatically switched off after 5 minutes of non-use. To reactivate the instrument press the ON/OFF key. This feature can be disabled by entering the setup mode and selecting the "AoF" item (see SETUP section for details).
- 6 TDS reading is obtained multiplying the EC reading by the TDS factor, which has a default value of 0.50. It is possible to change the TDS factor in the 0.40 to 0.80 range by entering the setup mode and selecting the "tdS" item (see SETUP section). Always set the reference temperature to 25°C when measuring TDS.
- 7 When the use of an alternate function (MR, SETUP, CFM, FIXED, TC and HOLD) is requested, press and hold the SHIFT key first and then the second key.

AUTORANGING

The EC and TDS scales are autoranging. The meter automatically sets the scale with the highest possible resolution.



By pressing SHIFT+FIXED, the autoranging feature is disabled and the current range is frozen on the LCD. "FIXED" symbol blinks on the LCD. To restore the autoranging option press SHIFT+FIXED again.

Note: Autoranging is automatically restored if the RANGE key is pressed, if the setup or calibration modes are entered and if the meter is turned off and back on again.

AUTO ENDPOINT MODE

The Auto Endpoint feature allows the user to freeze the display, when a stable reading is reached (EC/TDS/NaCl and temperature range).



To enter the Auto Endpoint mode, press SHIFT+HOLD keys.

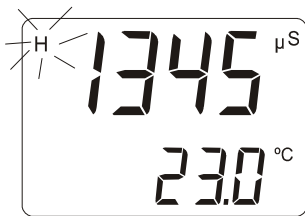

The LCD will show the current reading together with a blinking "H" tag.

When measurement becomes stable, the "H" symbol stops blinking and the measured value is frozen on the display.

To exit this mode and return to normal operations, press again SHIFT+HOLD.

Note: While in Auto Endpoint mode, current measurement (both stable and unstable) can be stored in the meter memory by pressing the MEM key.

Note: While in Auto Endpoint mode, calibration mode can not be entered and it is not allowed to change the temperature compensation and the range options.

TEMPERATURE COMPENSATION

Three options of compensating temperature are available:

Automatic (Atc): The probe has a built-in temperature sensor; the value of the temperature is used to automatically compensate the EC/TDS reading. This is the default option.

Manual (Mtc): The temperature value, shown on the lower LCD, can be manually set by the user with the up and down arrow keys. The "°C" symbol blinks when this option is active.

No Compensation (notc): The temperature reading shown on the lower LCD is not taken into account. The reading displayed on the upper LCD is the actual EC or TDS value. The "%TC" symbol blinks when this option is active.



To select the desired option press the ATC key until the option is briefly displayed on the LCD.

Instruction Manual Mi 306 EC/TDS Meter

If temperature compensation is active, measurements are compensated using a default temperature coefficient of 1.90 %/°C.

It is possible to select a different temperature coefficient (TC) in the 0.00 to 6.00 %/°C range by entering the setup mode and selecting the "tc" item (see SETUP section for details).



The current temperature coefficient can be quickly viewed pressing SHIFT+ATC. The value is briefly displayed on the lower LCD.

EC/TDS CALIBRATION

EC calibration is a single point procedure. Selectable calibration points are: 0.0, 84.0 $\mu\text{S}/\text{cm}$, 1413 $\mu\text{S}/\text{cm}$, 5.00 mS/cm , 12.88 mS/cm , 80.0 mS/cm , 111.8 mS/cm .

To enter EC calibration select the EC range and press the CAL key.

Note: TDS reading is automatically derived from the EC reading and no specific calibration for TDS is needed. Pressing CAL while TDS range is selected has no effect.

Rinse the probe with some of the calibration solution or deionized water. Immerse the probe into the solution. The sleeve holes must be completely submerged. Tap the probe repeatedly to remove any air bubbles that may be trapped inside the sleeve.

Begin with Zero calibration, just leave the dry probe in air.

The indications "REF" and "CAL" are displayed. The upper LCD shows the uncalibrated EC reading. The lower LCD shows the buffer value. The stability indicator "~" blinks.

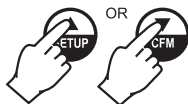
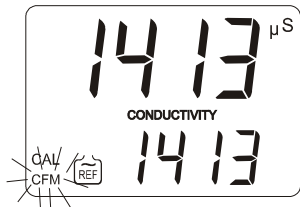

Select the desired value of buffer with the ▲ and ▼ keys, if necessary.

When the "~" symbol stops blinking, the reading is stable. The "CFM" indication starts blinking on the LCD asking for confirmation.



Press SHIFT+CFM to confirm the calibration.

If everything is satisfactory, the meter displays the "Stor Good" message and returns to measurement mode.

Notes

- I. The meter uses 1.90%/°C compensation factor during calibration. If the setup item "tc" has been set to a different value, when exiting the calibration mode the value displayed on the upper LCD could be different from the nominal buffer value.
- II. It is possible to set the cell constant value directly without following the calibration procedure. To set the cell constant enter the setup mode and select "CEL" (see SETUP for details).
- III. Press SHIFT+CFM to confirm. The meter returns to measurement mode.

NaCl CALIBRATION

Calibration is 1-point at 100.0% NaCl. Use the **MA 9066** calibration solution (sea water solution) as a 100% NaCl standard solution.

- To enter NaCl calibration select the NaCl from "RANGE" key and press CAL.
- Rinse the probe with some of the calibration solution or deionized water. Immerse the probe into **MA9066** solution. The sleeve holes must be completely submerged. Tap the probe repeatedly to remove any air bubbles that may be trapped inside the sleeve.
- The indications "STD" and "CAL" are displayed. The upper LCD shows the uncalibrated NaCl reading in percentage. The lower LCD shows "100".
- When the "~" symbol stops blinking, the reading is stable. The "CFM" indication starts blinking on the LCD asking for confirmation.



• Press SHIFT+CFM to confirm the calibration.

- If everything is satisfactory, the meter displays the "Stor Good" message and returns to measurement mode.

Note: If the uncalibrated reading is too far from the expected value, the calibration is not recognized. The "CFM" indication does not appear; the "~" and "STD" symbols blink to signal wrong or contaminated calibration solution.

LOGGING FUNCTION



To store the current reading in memory press the MEM key while in measurement mode. The LCD will display "Stor" along with the "SAMPLE" indication and the sample number for a few seconds.



By pressing the MEM key a complete set of information is memorized: date, time, EC/TDS/NaCl and temperature readings.

Up to 250 samples can be stored into memory.

When the memory is full and the MEM key is pressed, the sample will not be stored and the LCD will display "FULL". In this case it is necessary to delete some data from memory to proceed.



To view logged data



To retrieve the memorized information press SHIFT+MR.

The meter displays the day and month (upper LCD) and the number (lower LCD) of the last logged sample. The "ZERO" indication will be displayed if no samples are stored in memory.

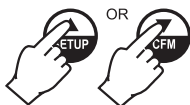

- Select the desired sample number with the arrow keys. Pressing the ▲ key while the last sample is displayed causes the meter to go to the first sample.



- Press RANGE to view remaining data of the selected sample. After the date information, the remaining data will be displayed in the following order:

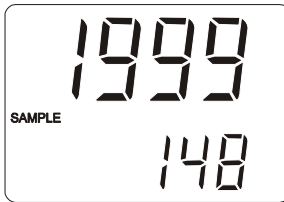

year

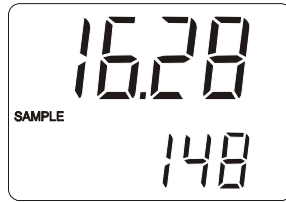

hour

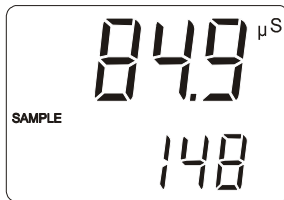

- EC, TDS, NaCl reading
 "----" means reading out of range
 or no probe was connected.



- temperature reading
 "----" means reading out of range.

- It is always possible to skip to another sample using the up and down arrow keys. For example, if the reading of a sample is displayed, pressing the up arrow key will cause the meter to display the reading of the next sample.
- At any time it is possible to return to normal operational mode by pressing SHIFT+MR.

To delete logged data

It is possible to delete a single sample or all the memory at one time.

To delete a single sample:



- Enter the viewing logged data mode and select the desired sample number.
- Press SHIFT+HOLD. The "CFM" indication starts blinking asking for confirmation.
- Press the SHIFT+CFM to confirm deletion.



Note: Press SHIFT+HOLD to escape without data deletion.

When viewing through the logged data, the "NULL" message will be displayed when selecting a deleted sample.

To delete all data in memory:



- Enter the viewing logged data mode.
- Press SHIFT+TC. The "CFM" indication will start blinking asking for confirmation.
- Press SHIFT and CFM to confirm deletion.

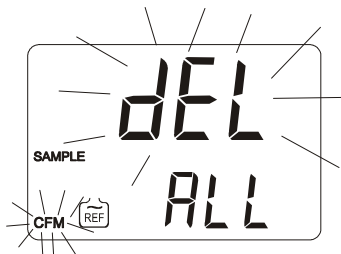

Note: Press SHIFT+TC to escape without data deletion.

Note: If no samples are stored in memory and a deletion is attempted, the meter will show the message "Zero" and then returns to normal operational mode.

DATA TRANSFER TO PC

Connect the meter to a PC through the RS232C output (the connector is located on the top of the meter). Use **MA 9351**(5 to 9 pin) connection cable.

Specifications

Isolated 8-bit data transmission

Baud Rate: 2400

Start bit: 1

Stop bit: 1

Parity bit: none

Sending Commands from PC

With any terminal programs it is possible to remotely control the instrument. Connect the meter to the PC through the **MA 9351** cable, start the terminal program and set the communication options as follows: 8, N, 1, no flow control.

To send a command to the meter the scheme is:

<command> <CR>

The computer sends the command expressed as a 3-character sequence and a CR character.

Note: All the terminal programs that support the ANSI escape sequence, represent the CR character with the string '^M'.

The commands available are as follows:

MOD - to request the firmware code of the meter.

RPA - to request the setup parameters setting.

LTB - to request the number of logged samples.

LOD - to request the logged data.

The meter answers with the following order:

status byte

date (ddmmyy)

time (hhmm)

measurement (binary)

temperature reading (binary)

At the end of the logged data the checksum (2 complement) is sent.

Note: The meter will send <CAN> if a corrupted or unknown command is received.

BATTERY REPLACEMENT

When the battery is low the meter will display the blinking battery symbol in the lower left corner of the LCD.

When the battery indicator appears, the meter can still work for about 20 hours.

A low battery condition will lead to unreliable readings. It is recommended to replace immediately the battery.

Battery replacement must only take place in a non-hazardous area using a 9V alkaline battery. Turn the meter off, remove the battery compartment cover on the rear of the meter and replace the rundown battery with a new one.

Install the battery while paying attention to its polarity and reattach the cover.

CONDUCTIVITY VS TEMPERATURE CHART

The conductivity of an aqueous solution is the measure of its ability to carry an electrical current by means of ionic motion. The conductivity invariably increases with increasing temperature. It is affected by the type and number of ions in the solution and by the viscosity of the solution itself. Both parameters are temperature dependent. The dependency of conductivity on temperature is expressed as a relative change per degree Celsius at a particular temperature, commonly as percent per °C.

The following table lists the temperature dependence of the calibration buffers.

°C	°F	-	-	-	-	-	-
(µS/cm)							
19	66.2	11430	1251	74	71300	100200	4429
20	68	11670	1278	76	72400	102100	4523
21	69.8	11910	1305	78	74000	104000	4617
22	71.6	12150	1332	79	75200	105900	4711
23	73.4	12390	1359	81	76500	107900	4805
24	75.2	12640	1386	82	78300	109800	4902
25	77	12880	1413	84	80000	111800	5000
26	78.8	13130	1440	86	81300	113800	5096
27	80.6	13370	1467	87	83000	115700	5190
28	82.4	13620	1494	89	84900	117700	5286
29	84.2	13870	1521	90	86300	119700	5383
30	86	14120	1548	92	88200	121800	5479
31	87.8	14370	1575	94	90000	123900	5575

ACCESSORIES

MA 814D/1	4-ring EC probe with DIN connector and 1 m (3.3') cable
M1 0030B	12880 $\mu\text{S}/\text{cm}$ calibration solution, 20 ml sachet, 25 pcs.
M1 0031B	1413 $\mu\text{S}/\text{cm}$ calibration solution, 20 ml sachet, 25 pcs.
M1 0033B	84 $\mu\text{S}/\text{cm}$ calibration solution, 20 ml sachet, 25 pcs.
M1 0035B	111.8 mS/cm calibration solution, 20 ml sachet, 25 pcs.
MA 9060	12880 $\mu\text{S}/\text{cm}$ calibration solution, 230 ml bottle
MA 9061	1413 $\mu\text{S}/\text{cm}$ calibration solution, 230 ml bottle
MA 9063	84 $\mu\text{S}/\text{cm}$ calibration solution, 230 ml bottle
MA 9065	111.8 mS/cm calibration solution, 230 ml bottle
MA 9069	5000 $\mu\text{S}/\text{cm}$ solution, 230 ml bottle
MA 9351	RS232 connection cable (5 to 9 pin) with 2 meters cable (for Mi306)
MA 9066	100% NaCl Calibration solution, 230 ml bottle

For your Safety don't use or store the instrument in hazardous environments. To avoid damages or burns, do not perform any measurement in microwave ovens.

WARRANTY

These instruments are warranted against defects in materials and manufacturing for a period of 3 years from the date of purchase. Electrodes and Probes are warranted for 6 months.

If during this period the repair or replacement of parts is required, where the damage is not due to negligence or erroneous operation by the user, please return the instruments, electrode and probe to either distributor or our office and the repair will be effected free of charge.

Damage due to accidents, misuse, tampering or lack of prescribed maintenance is not covered by the warranty.

Milwaukee instruments reserves the right to make improvements in design, construction and appearance of its products without advance notice.

THANK YOU FOR CHOOSING



Sales and Technical Service Contacts:

Milwaukee Electronics Kft.
Alsóikötő sor 11.
6726, Szeged, Hungary
Tel: +36-62-428-050
Fax: +36-62-428-051
e-mail: sales@milwaukeeinst.com

Milwaukee Instruments, Inc.
2950 Business Park Drive Rocky Mount, NC
27804 USA
Tel: +1 252 443 3630
Fax: +1 252 443 1937
e-mail: sales@milwaukeetesters.com

www.milwaukeeinst.com